

# KPT 1

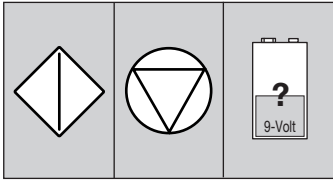

1

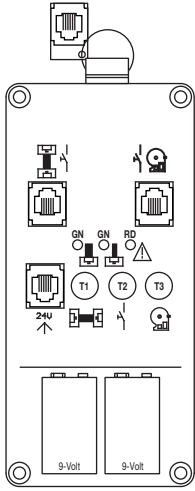
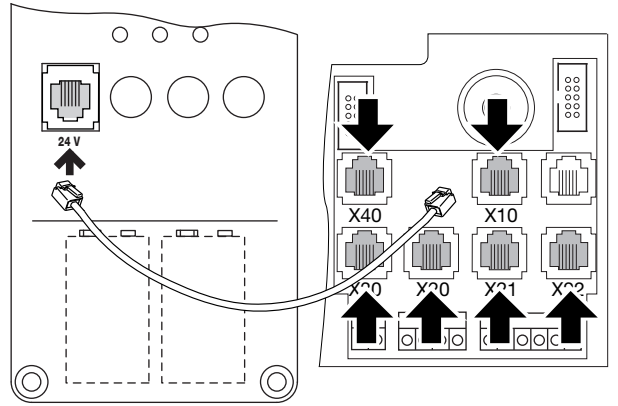
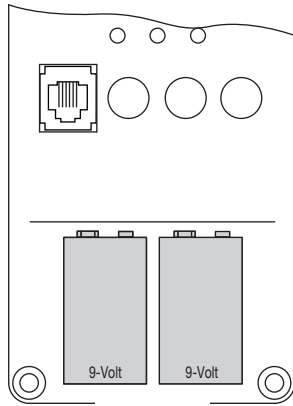

2

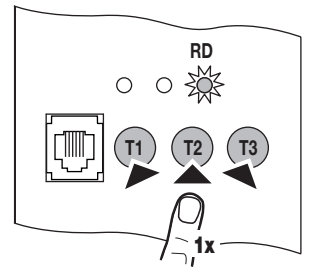
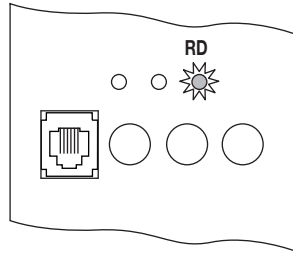
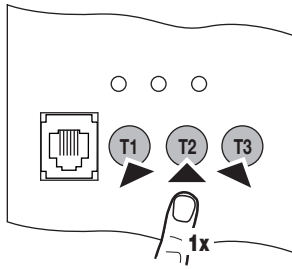

3.1

1

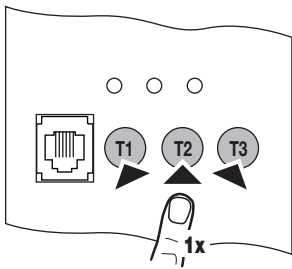
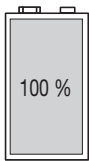

2

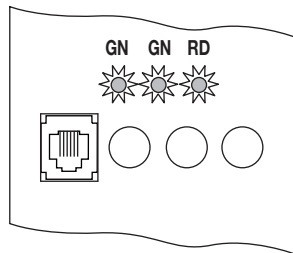

3

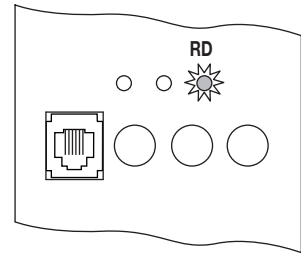

3.2

1

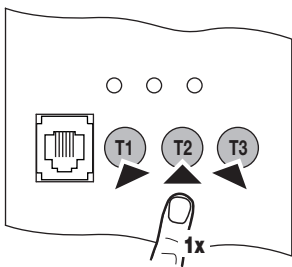

2

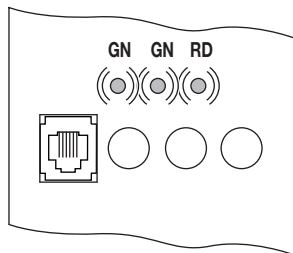

3

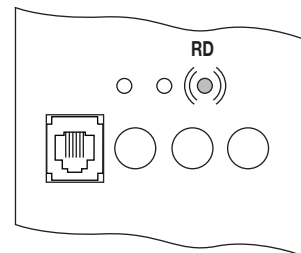

# KPT 1

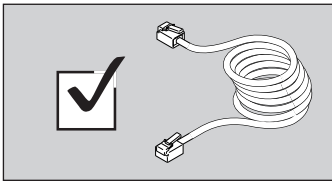
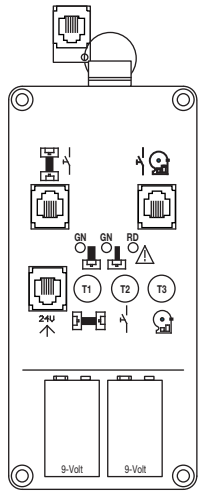

1

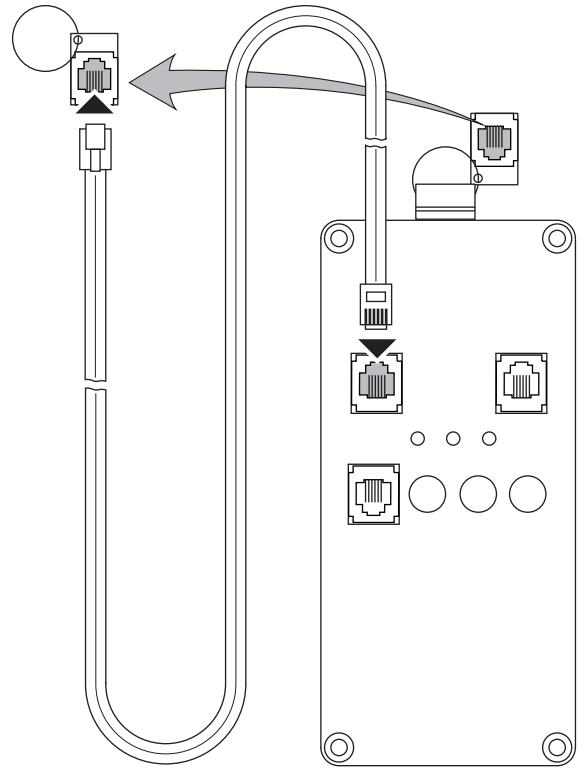
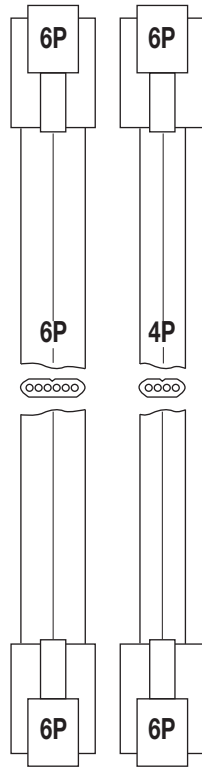

2

1

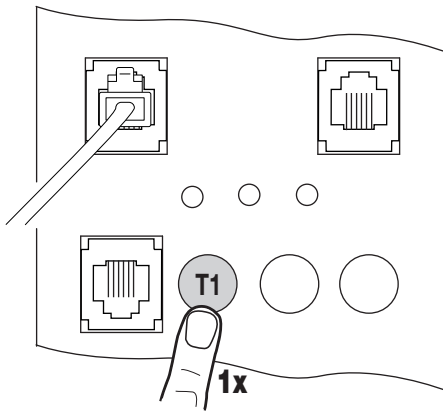

2

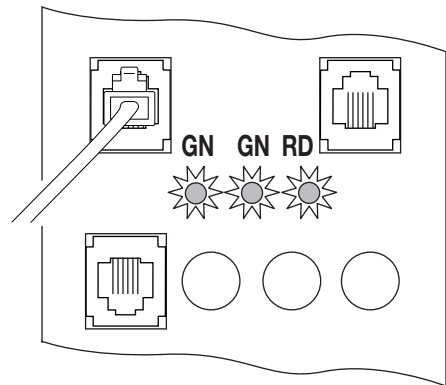

3a

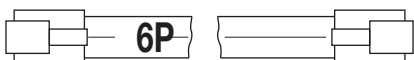
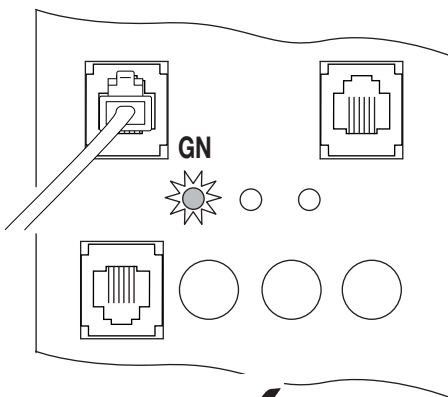

3b

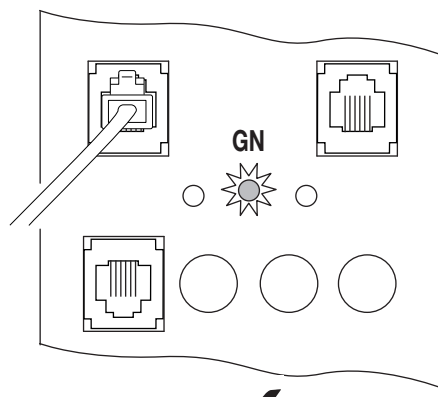

3c

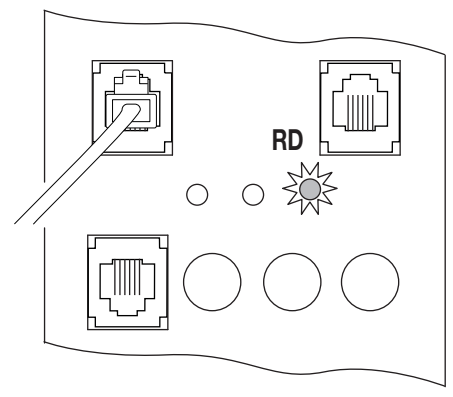

# KPT 1

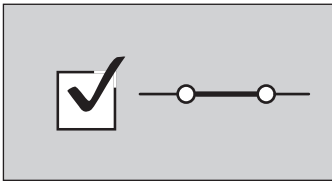
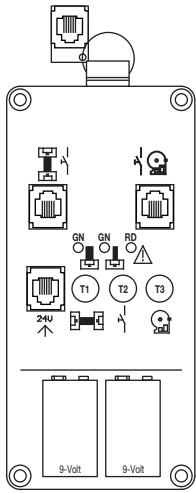

1

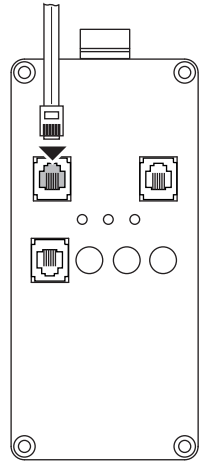
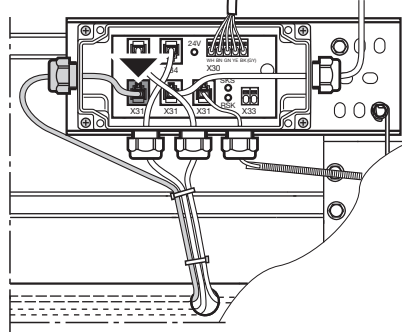
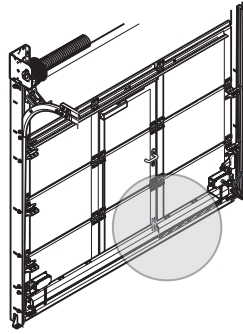
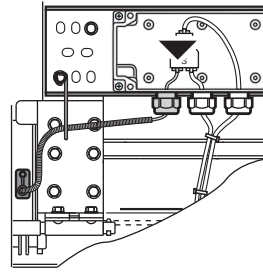
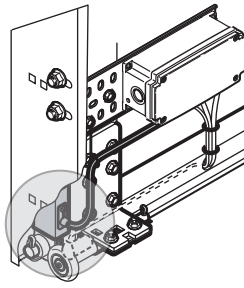

2

1

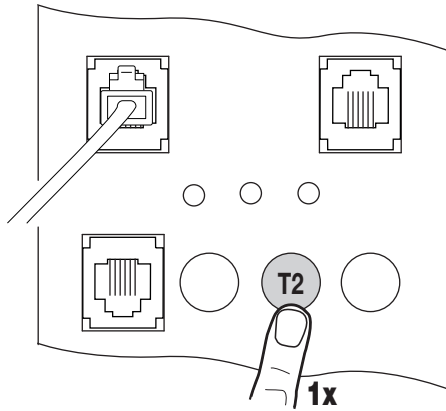

2

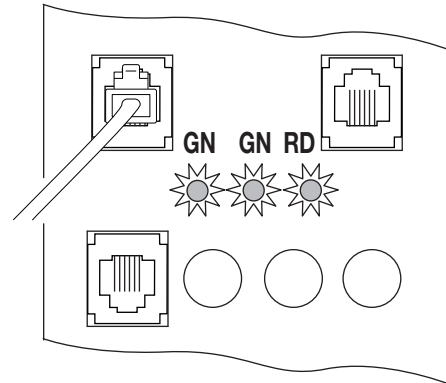

3a

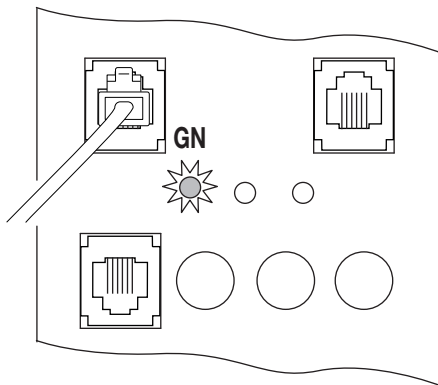

3b

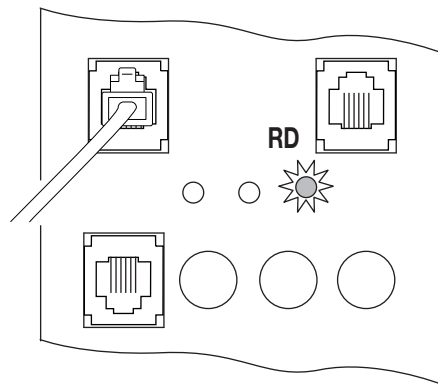

# KPT 1

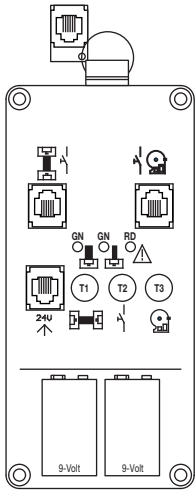

1

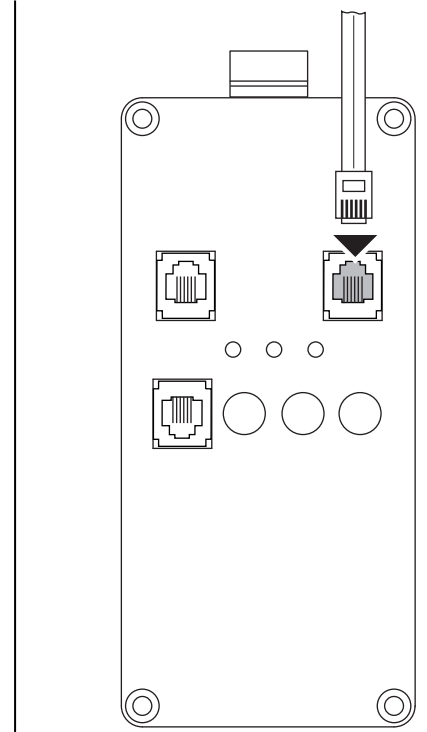
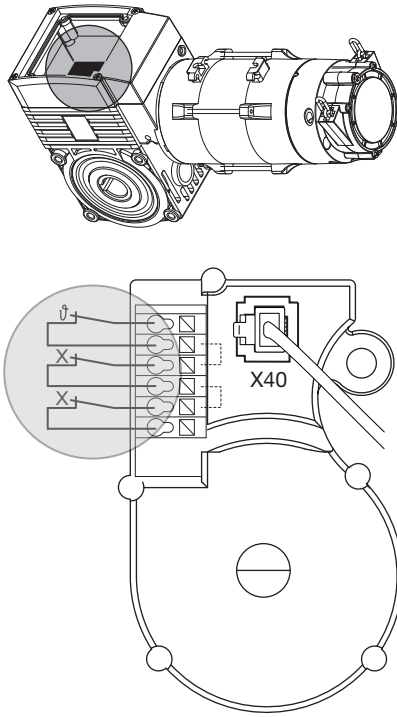

2

1

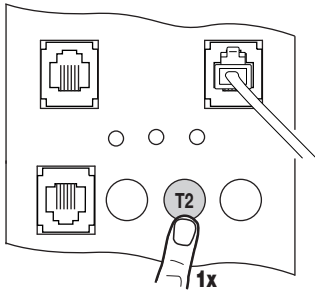

2

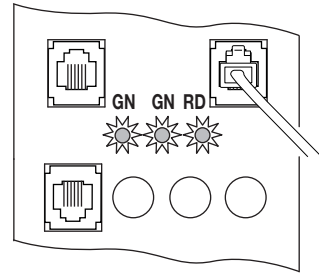

3a

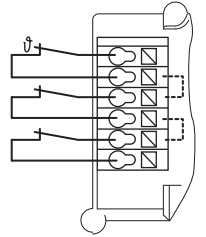
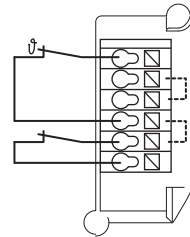
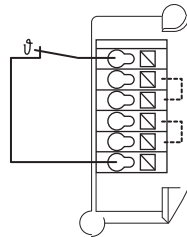
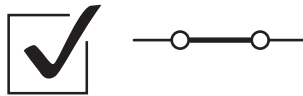
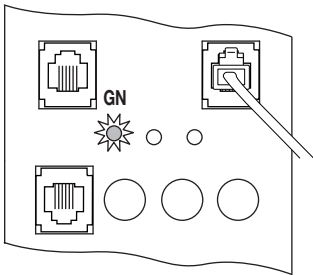

3b

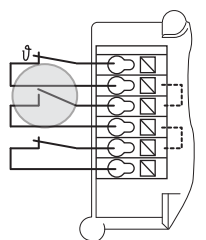
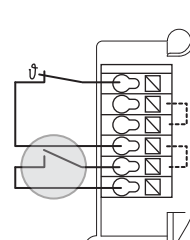
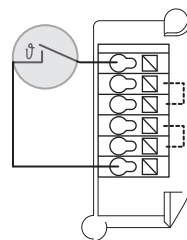
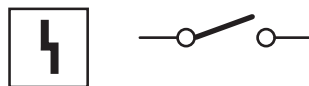
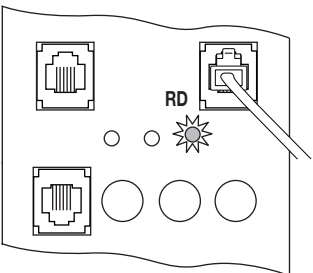

# KPT 1

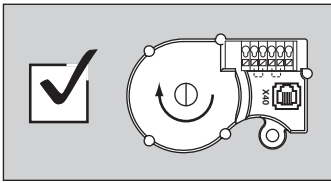
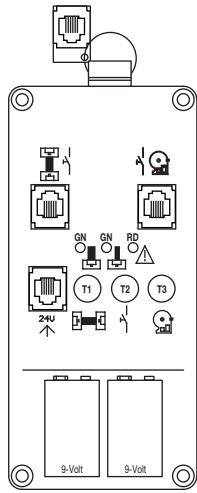

1

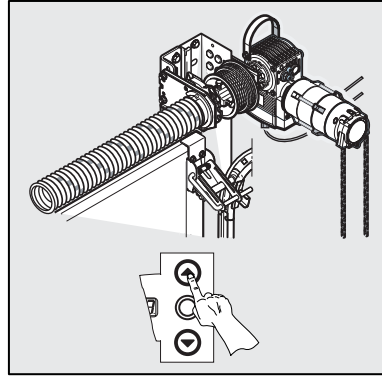
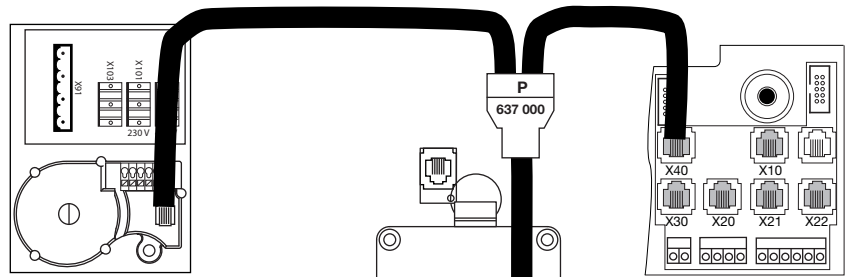

2

1

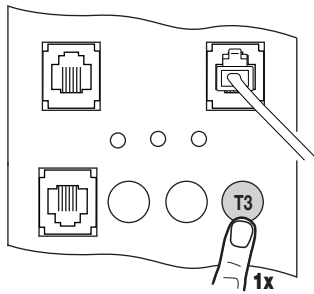

2

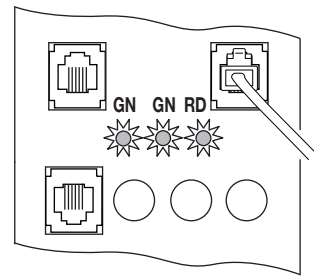

3a

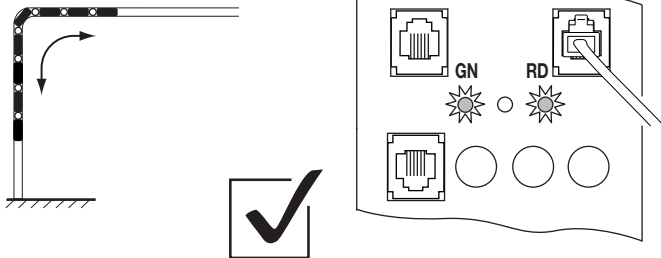

3b

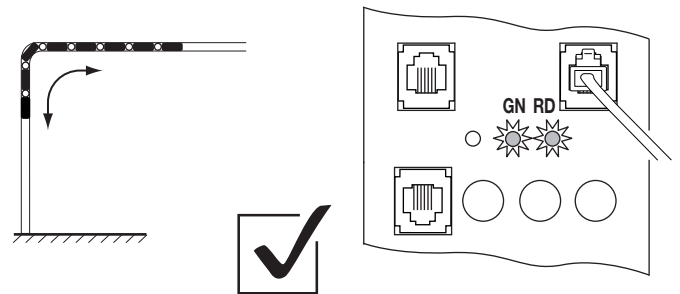

3c

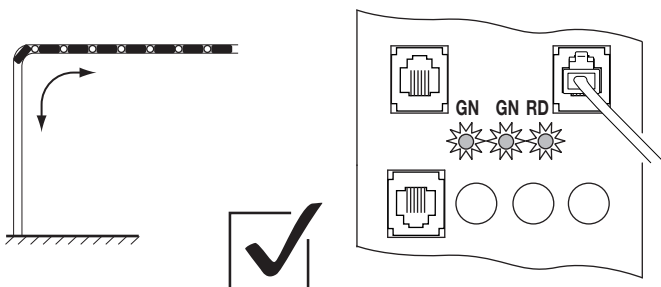

3d

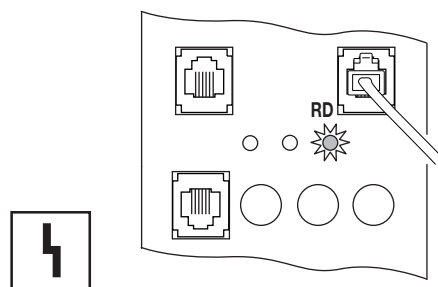

# KPT 1

1

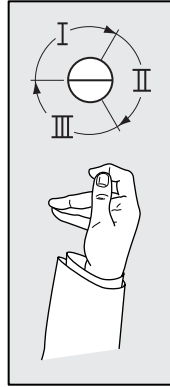
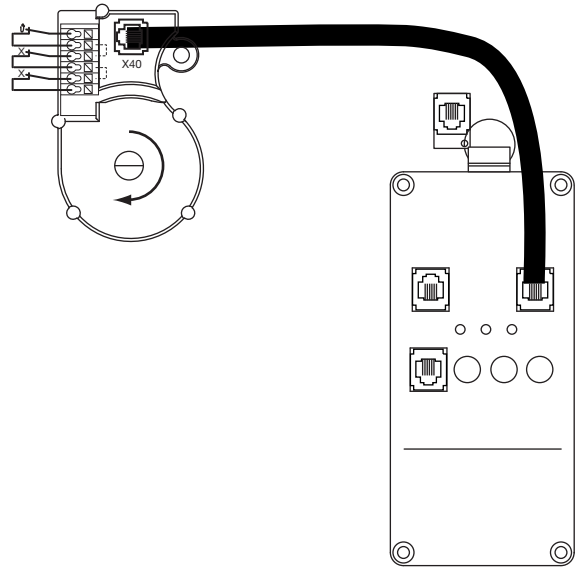
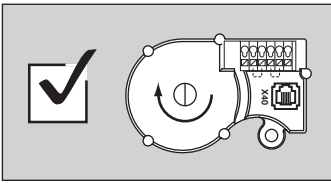
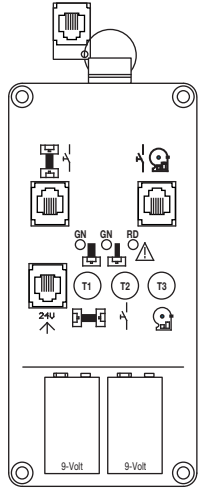

2

1

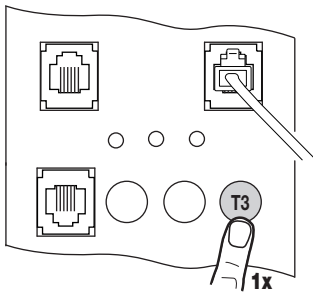

2

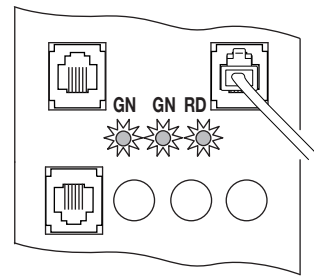

3a

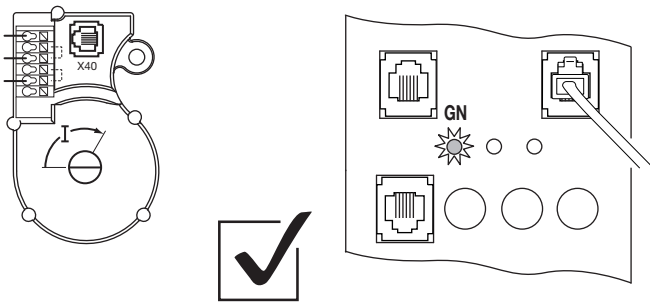

3b

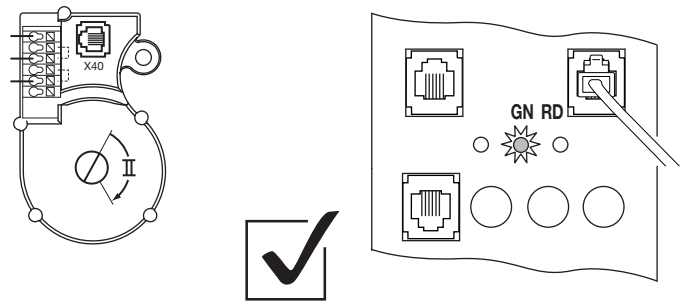

3c

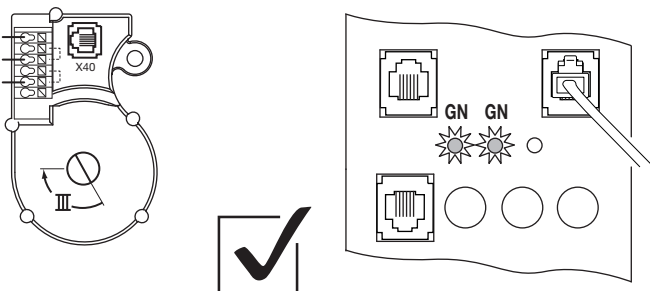

3d

